

MAST STORAGE SYSTEM / MÂTAGE DE TANGON

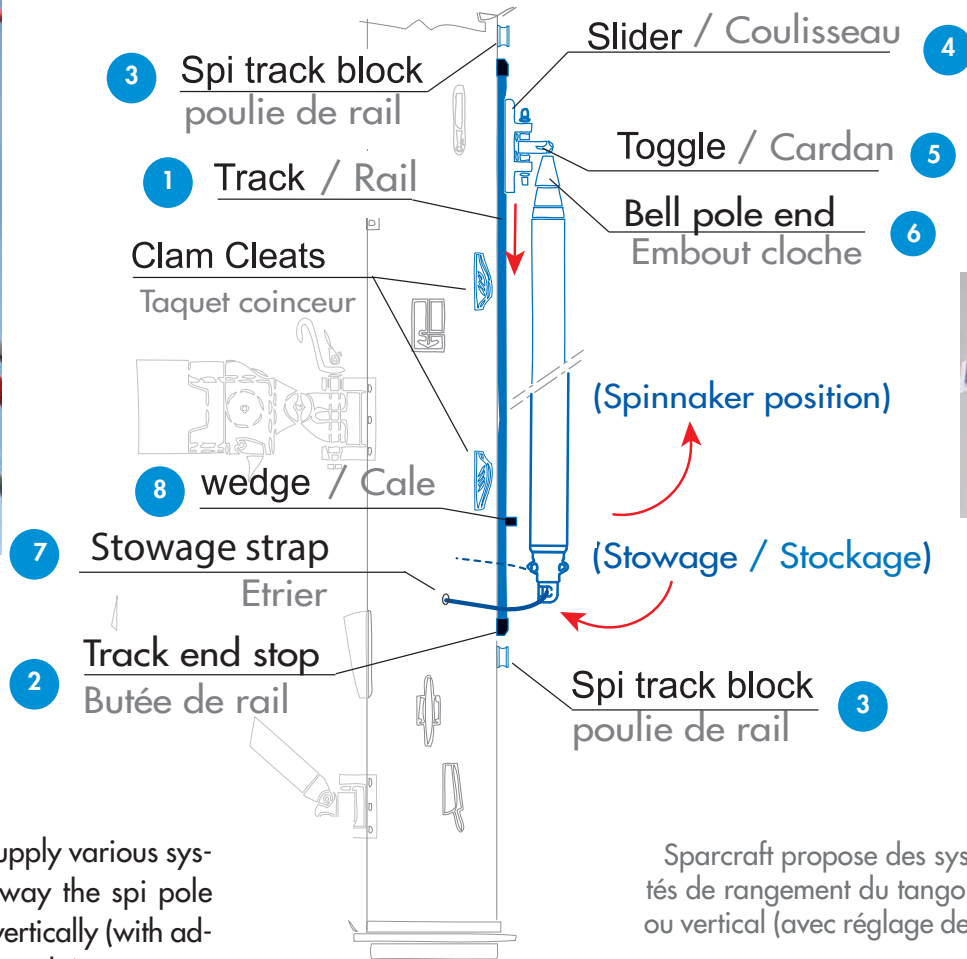

Sparcraft can supply various systems to store away the spi pole horizontally or vertically (with adjustment of the height).

■ **Mast storage systems** : allows you to put away the spar vertically on the front side of the mast, to free the deck, and to adjust the height of the spi pole in position. The stowage is done, according to the section, with the jaw on a large stainless steel strap and a wedge.

■ **Spi pole track (see against)**
 - Track stops available with or without sheave for tracks 32 x 5,5;
 - Track stops with sheaves available for F40 ball tracks.

■ **Sliders / toggles / car bearings / spi track blocks** : Available per sets, or separate parts (please see next pages).

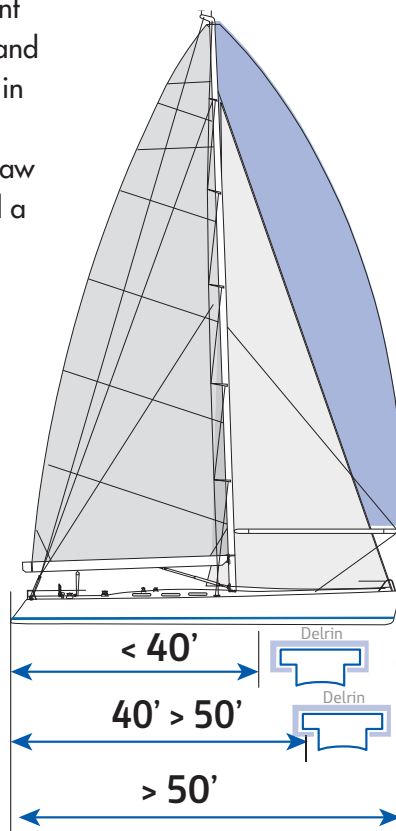

Sparcraft propose des systèmes adaptés de rangement du tangon, horizontal ou vertical (avec réglage de sa hauteur).



■ **Systèmes de mâtage de tangon en face avant du mât** : permettent de stocker l'espar en vertical pour libérer le pont et de régler la hauteur du tangon. Le verrouillage est effectué, suivant profil, avec la mâchoire du tangon en pied de mât sur un anneau et une cale Delrin de maintien (pour rail 32 x 5,5).

■ **Rails de tangon (voir schema)** :
 - Embout de rail disponible avec ou sans réas pour rail 32 x 5,5;
 - Butées avec réas pour rails F40.

■ **Coulisseaux / cardans / patins / poulies de rail de tangon** : Plusieurs configurations possibles, par ensemble, suivant profils ou vendus séparément (voir pages suivantes).

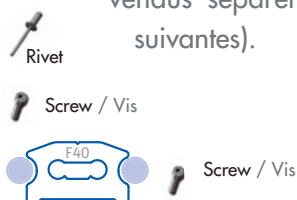

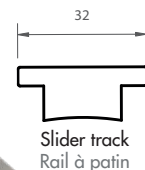
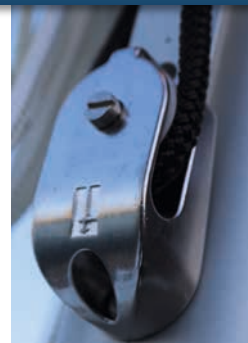

TRACK PARTS / COMPOSANTS DE RAIL	
Part number / Réf.	Description / Désignation
TRACK / RAIL	
1 SLIDER TRACK / RAIL A PATIN	
33511.174.555	TRACK 32X5,5 SILVER ANO LG 6M, FOR SLIDER, TO POP (< 40') RAIL 32X5,5 ANO INCO LG 6M, A PATIN, A RIVETER (< 40 PIEDS)
33511.744.963	TRACK 32X5,5 SILVER ANO LG 6M, FOR SLIDER, TO SCREW (> 40') RAIL 32X5,5 ANO INCO LG 6M, A PATIN, A VISSER (>40 PIEDS)
1 F40 BALL TRACK / RAIL A BILLE F40	
45002.154.033	TRACK F40 ANO LG 3,4M TO SCREW / RAIL F40 ANO LG 3.4M À VISSER
ACCESSORIES / ACCESSOIRES	
2 TRACK END STOPS / BUTEES DE RAIL	
33513.000.021	FOR TRACK 32X5, WITH SCREWS / POUR RAIL 32X5,5, AVEC VIS
45011.000.015	FOR TRACK F40, WITH SCREWS / POUR RAIL F40, AVEC VIS
3 BLOCKS FOR UP & DOWN / POULIES DE RAIL DE TANGON POUR VA ET VIENT	
33513.000.016	BLOCK FOR TRACK 32 x 5,5 (S STEEL) / POULIE / BUTEE DE RAIL 32 x 5,5 (INOX)
33513.000.017	BLOCK FOR TRACK F40 (S STEEL) / POULIE / BUTEE DE RAIL F40 (INOX)
SLIDERS & BELLS / COULISSEUX & CLOCHES	
4 5 6 SEE NEXT PAGE - VOIR PAGE SUIVANTE	

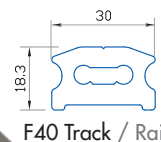

■ Vertical stowage system on the mast:
Stainless steel stowage strap + wedge

■ Stockage vertical du tangon sur le mât :
Étrier inox + cale

7 S/S STRAP / ÉTRIER INOX	
33515.408.733	S/S COMPLETE STRAP (middle size) / ÉTRIER INOX COMPLET (modèle standard) S330 - S400 - S510 - S622 - S830 - S1060 - S1210 - S1395 - S365E - S560E - S760E - S980E - S1420E
33515.000.045	S/S COMPLETE STRAP (large size) / ÉTRIER INOX COMPLET (gros modèle) S1540 - S1630 - S1980E - S2100 - S3410 - S3800E
8 WEDGE (Depending on pole ø) / CALE (selon ø tangon)	
33515.408.732 (on track / sur rail)	DELRIN WEDGE for ø 100 max Spi pole / CALE DELRIN pour tangon ø 100 maxi (S330 - S400 - S510 - S622 - S830 - S1060 - S1210 - S1395 - S1540 - S1630 - S365E - S560E - S760E - S980E - S1420E)
33515.408.011 (on mast / sur mât)	DELRIN WEDGE for ø 100 max Spi pole / CALE DELRIN pour tangon ø 100 maxi (S2100 - S3410 - S3800E)
33515.000.066 (on track / sur rail)	DELRIN WEDGE for ø 135 max Spi pole / CALE DELRIN pour tangon ø 135 maxi (S1540 - S1630 - S1980E - S2100 - S3410)



() Indicative sections / Profils donnés à titre indicatif

SPINNAKER EQUIPMENT - ÉQUIPEMENT DE SPI

SLIDERS & BELLS / COULISSEUX & CLOCHES

■ For TRACK / pour RAIL 32 X 5,5

TRACK 32 X 5,5 / RAIL 32 X 5,5		
SLIDER + TOGGLE + BELL CURSEUR + CARDAN + CLOCHE		
	UP & DOWN SHEET VA ET VIENT	WITH TRIGGER AVEC PISTON
Complete pack Ensemble complet	3350 5000 001	3350 5000 002
4 SLIDER / CURSEUR		
Complete slider Curseur complet	3350 3000 004	3350 3000 003
Slider body Corps curseur	3350 3000 014	
Pad/ Patin	(2 x) 33507175063	
Pin / Axe	40201100562	
TOGGLE + BELL / CARDAN + CLOCHE		
Complete toggle + Bell Cardan + cloche complet	3350 5000 004	
5 TOGGLE / CARDAN		
Toggle / Cardan	3351 7179 380	
6 BELL / CLOCHE		
Complete bell Cloche complète	3350 5000 007	
Bell / Cloche	3350 5404 421	
Triger / Gâchette	3805 4044 22G	
Spring / Ressort	2924 0800 030	
Pin/ Axe	4002 0212 065	



335 0300 0003

Slider with trigger
curseur avec piston



335 1717 9380

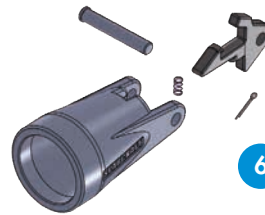

Pad / Patin



Ref: 33507175063

■ for TRACK / pour RAIL F40

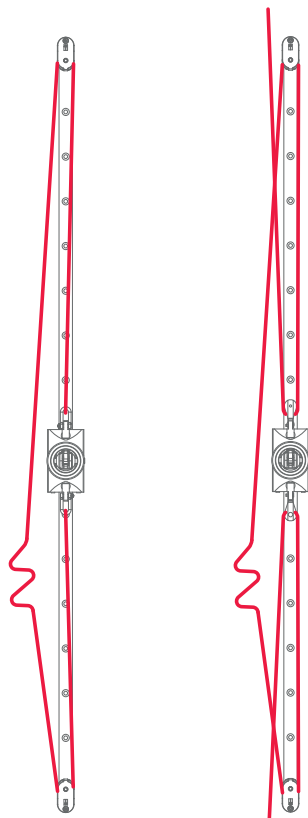

1:1 Control
Commande 1:1

2:1 Control
Commande 2:1



45004CNT403



335 1700 0001

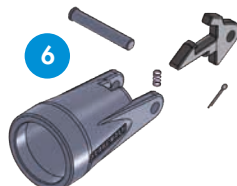

TRACK F40 / RAIL F40		
SLIDER + TOGGLE + BELL / CURSEUR + CARDAN + CLOCHE		
	2:1 CONTROL COMMANDE 2:1	1:1 CONTROL COMMANDE 1:1
Complete pack Ensemble complet	335 0900 0006	335 0900 0007
Block/ Poulie	(2 x) 482 0800 7203	
Schakle / Manille	-	(2 x) 460 0115 1005
SLIDER+ TOGGLE / CURSEUR + CARDAN		
Complete slider Curseur complet	335 0900 0001	
Slider body / Corps curseur	4 45004CNT403	
Balls / Billes	441 200 1008	
Pin / Axe	335 0201 0015	
Block / schakle adaptor Adaptateur poulie/manille	335 0990 0002	
Toggle / Cardan	5 335 1700 0001	
6 BELL / CLOCHE		
Complete bell Cloche complète	335 0500 0007	
Bell / Cloche	335 0540 4421	
Triger / Gâchette	380 5404 422G	
Spring / Ressort	292 4080 0030	
Pin/ Axe	400 2021 2065	

CURSEURS À ŒIL / EYE SLIDERS

■ S/s eye slider for track 32 x 5,5

■ Curseurs à œil inox pour rail 32 x 5,5

DESCRIPTION / DÉSIGNATION	TRACK 32 X 5,5 / RAIL 32 X 5,5	
	UP & DOWN VA & VIENT	WITH TRIGGER / AVEC PISTON
Standard eye slider / Curseur à œil standard	-	33503175325
Reinforced eye slider / Curseur à œil renforcé	-	33503175326
	33503175003	-



335 0317 5325

ANNEAUX FIXES DE TANGON / FIXED SPI RINGS

■ Fixed Spi rings

■ Anneaux de tangon fixes

FIXED SPI RINGS / ANNEAUX DE TANGON			
Mast section / Profil	Description / Désignation	Part number Référence	Ring Diam. Ø Anneau
S80	S/steel ring with rivets Anneau inox avec rivets	33501000125	Ø35
S35-S50-S67-S137 S180-S260	S/steel ring with leveling pad and rivets Anneau inox avec cale et rivets	33501000115	Ø40
S330 to / à S830	S/s steel ring with leveling pad and rivets Anneau inox avec cale et rivets	33501000105	Ø50



33501000125



33501000115 & 33501000105

STOCKAGE TANGON / SPINNAKER POLE STORAGE

■ Horizontal storage

■ Stockage horizontal

DECK EQUIPMENT / ACCASTILLAGE DE PONT	
Description / Designation	Part number / Réf.
Stainless steel pole storage ring set Support inox de pont pour tangon	33515408080



SECTIONS TANGON / TUBE POLE SECTIONS

ALUMINIUM TUBE SECTIONS / SECTIONS TUBE ALUMINIUM

Part number Référence	Tube ø ø Tube (mm)	Inertia Inertie (cm4)	Weight Poids (kg/m)	Thickness Épaisseur
230 3040 0263	40	4,5	0,67	2
230 1055 6703	55	12,0	0,95	2
230 1063 7503	63	22,0	1,36	2,5
230 1080 5303	80	37,0	1,34	2
230 1090 5403	90	78	2,20	3
230 1100 6003	100	108	2,50	3
230 1125 7003	125	180	2,59	2,5

